

Campbeltown Airport Footprint 2023

In accordance with the UK
Government's Conversion Factors
for Company Reporting

Report for Highland and
Islands Airports Limited (HIAL)

Rev 01 21/09/23



CONTENTS

PROJECT SUMMARY

CARBON FOOTPRINT – MARKET-BASED

CARBON FOOTPRINT – LOCATION-BASED

KEY STATS

RECOMMENDATIONS

METHODOLOGY

ANNEX



GLOSSARY

	Definition
Arisings	Materials forming the secondary or waste products of industrial operations.
ATM	Air traffic movements – an aircraft take-off or landing at an airport. For airport traffic purposes one arrival and one departure is counted as two movements.
Carbon dioxide equivalent (CO ₂ e)	The carbon dioxide equivalent (CO ₂ e) allows the different greenhouse gases to be compared on a like-for-like basis relative to one unit of CO ₂ . CO ₂ e is calculated by multiplying the emissions of each of the six greenhouse gases by its 100-year global warming potential (GWP).
Carbon footprint	A carbon footprint measures the total greenhouse gas emissions caused directly and indirectly by a person, organisation, event or product. A carbon footprint is measured in tonnes of carbon dioxide equivalent (tCO ₂ e).
Emission factor	An emission factor is a representative value that attempts to relate the quantity of a pollutant released to the atmosphere with an activity associated with the release of that pollutant.
GHG	Greenhouse gas – a gas in an atmosphere that absorbs and emits radiation within the thermal infrared range. This process is the fundamental cause of the greenhouse effect. The primary greenhouse gases in Earth's atmosphere are water vapour, carbon dioxide, methane, nitrous oxide, and ozone.
Outside of Scope	All fuels with biogenic content (e.g. 'Diesel and petrol (average biofuel blend)') should have the 'Outside of Scope' emissions reported to ensure a complete picture of an organisations' emissions are created. The emissions are labelled 'Outside of Scope' because the Scope 1 impact of these fuels has been determined to be a net '0' (since the fuel source itself absorbs an equivalent amount of CO ₂ during the growth phase as the that CO ₂ is released through combustion).
PAX	Number of passengers in the reporting year.
APU	The auxiliary power unit that supplies power to ground operations when an aircraft is stationary.
CAA	Civil Aviation Authority, a source of aviation statistics.
GSE	Ground Support Equipment such as vehicles that assist operations at the airport.

PROJECT SUMMARY

BACKGROUND

HIAL is a public corporation owned by the Scottish Ministers and subsidised by the Scottish Government in accordance with Section 34 of the Civil Aviation Act 1982. HIAL operates and manages 11 airports in total; Barra, Campbeltown, Campbeltown, Dundee, Inverness, Islay, Kirkwall, Stornoway, Sumburgh, Tiree and Wick. Campbeltown served 6,712 passengers with a total of 1,403 aircraft movements in the 2023 financial year. The 2023 financial year for HIAL covers the period 1st April 2022 to 31st March 2023.

The calculation of the annual carbon footprint will help HIAL and the individual airports understand the different areas which contribute to their overall carbon footprint and monitor changes on a yearly basis. HIAL has committed to creating a Net Zero Aviation Zone by 2040 and so this process will help identify improvement opportunities, which will ultimately reduce HIAL's carbon footprint and associated costs. In addition, the carbon footprint will also form the baseline for emission reduction targets, allowing HIAL to measure the success of any management strategies implemented.

CARBON FOOTPRINT

SUMMARY

All emissions have been calculated in line with the GHG Protocol, to ACA Level 4 standard and ISO 14064-1. The emissions sources included are shown in the figure below.

Emissions figures are reported using the location-based methodology unless clearly indicated otherwise. A market-based baseline emissions profile can be seen towards the end of this report. For a detailed explanation on this, please see [this slide](#).

A detailed explanation of the methodology and assumptions used to estimate the footprint can be found in the technical annex.

Scope 3 “Indirect Emissions”

- Aviation emissions: LTO, CCD, engine testing
- Passenger surface access
- Fuel used in vehicles and ground support equipment owned by third parties
- Staff commute & business travel
- Tenant electricity
- Electricity well-to-tank and transmission and distribution losses
- Waste: Disposal & virgin material production
- De-Icer used on aircraft by third parties
- Water supply and wastewater treatment

The emissions included within each scope of the footprint can be seen below.

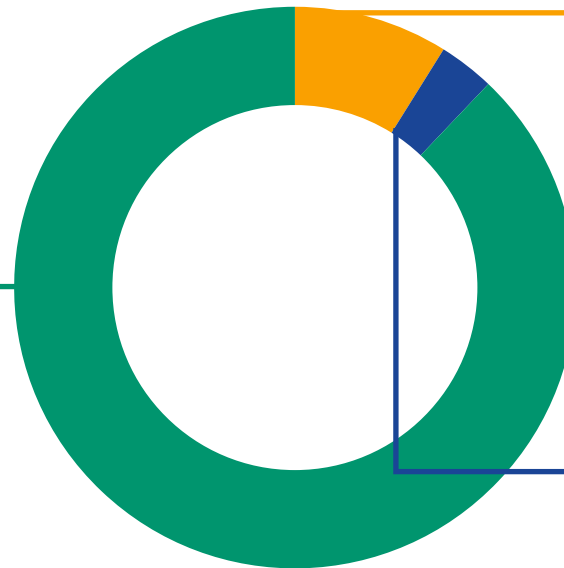

Scope 1 “Direct Emissions”

- Fuel used in: Vehicles and ground support equipment owned by Campbeltown Airport, generators and other equipment
- Refrigerant gases lost to atmosphere from chillers and air conditioners
- De-icer used on ground by Campbeltown Airport

Scope 2 “Indirect Emissions”

- Electricity used by Campbeltown Airport

CARBON FOOTPRINT

SUMMARY: MARKET BASED REPORTING

The Market Based methodology as outlined in the GHG Protocol, allows for organisations to report their carbon emissions reflecting their energy procurement decisions.

For Campbeltown Airport, their electricity is purchased under a zero emissions contract that is fully backed by Renewable Energy Guarantees of Origin (REGO) certificates. This means that under Market Based reporting rules, the Scope 2 electricity emissions are reported as zero emissions.

The following slides show the emissions reported under this methodology.

514 tCO₂e/year

93.4 % from scope 3 emission sources

Market Based Emissions Figures

Scope 3

“Indirect Emissions”

Emissions that arise as a consequence of the activities of the company, but occur from sources not owned or controlled by the company.

480 tCO₂e 93.4%

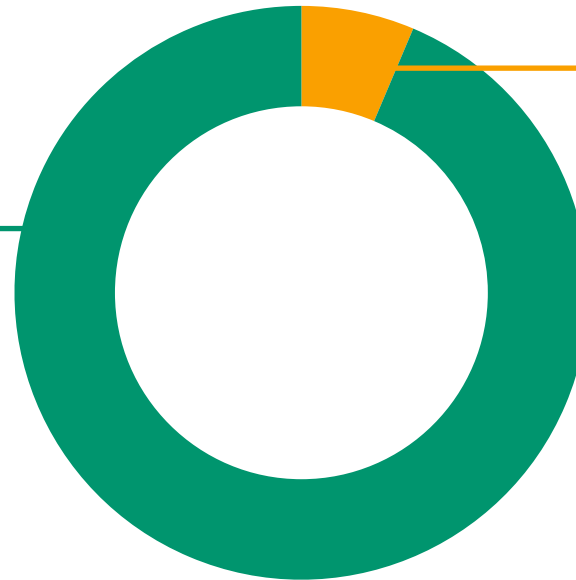

Scope 1

“Direct Emissions”

Emissions produced from sources linked to a company's assets.

33 tCO₂e 6.4%

Scope 2

“Indirect Emissions”

Emissions produced by the generation of electricity purchased from third parties and consumed in the company's assets.

0 tCO₂e 0%

CARBON FOOTPRINT

ANNUAL SUMMARY: MARKET BASED REPORTING

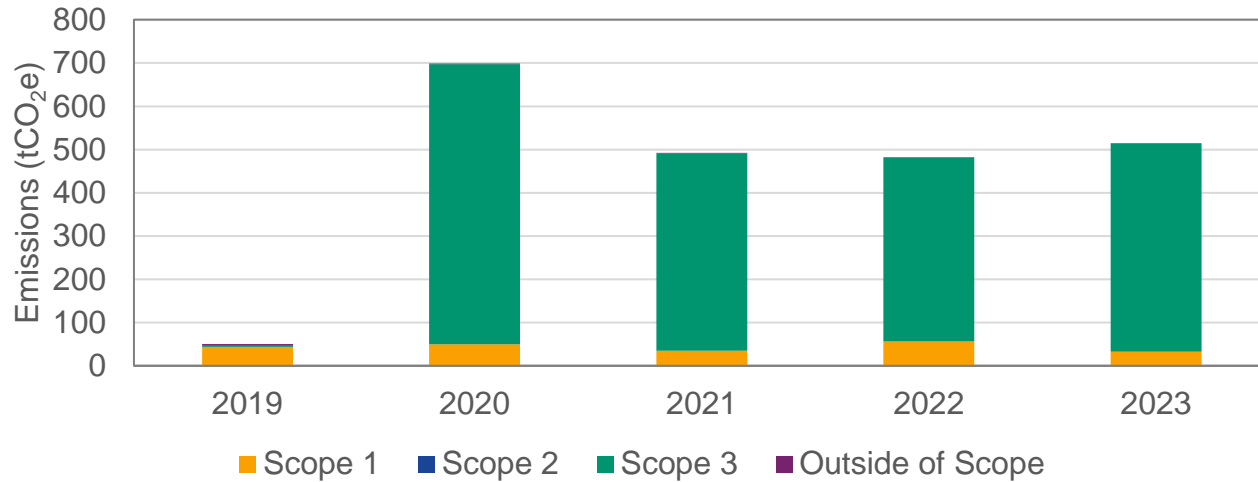

6.4 %

Scope 1

0 %

Scope 2

93.4 %

Scope 3

Electricity is purchased under a zero emissions contract, hence scope 2 electricity emissions are reported as zero emissions.

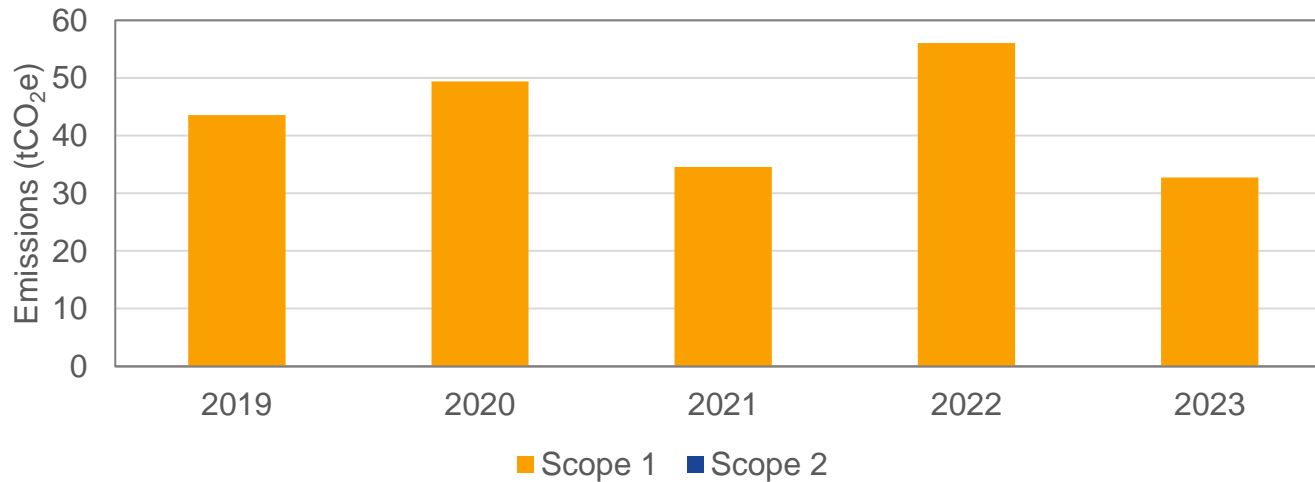

CARBON FOOTPRINT

BY EMISSION SOURCE

Market Based tCO ₂ e	Emissions (tCO ₂ e)	% of Scope	% of Total Emissions
Scope 1 – Total	33	100.0%	6.4%
Natural gas	0	0.0%	0.0%
Airport GSE	21	65.7%	4.2%
Fuel (heating and power)	11	32.8%	2.1%
Business travel	0	0.5%	0.0%
Refrigerants	0	0.0%	0.0%
Airport de-icer	0	0.0%	0.0%
Fire training	0	0.9%	0.1%
Scope 2 – Total	0	0.0%	0.0%
Airport electricity	0	0.0%	0.0%
Scope 3 - Total	480	100.0%	93.4%
Climb, Cruise and Descent (CCD)	185	38.6%	36.0%
Landing Take-off (LTO)	262	54.5%	50.9%
Passenger surface access	8	1.8%	1.7%
Tenant electricity	0	0.0%	0.0%
Electricity WTT <i>(reported since 2021)</i>	4	0.7%	0.7%
Electricity T&D	1	0.3%	0.2%
Waste	15	3.1%	2.9%
Staff commute	4	0.8%	0.7%
Third party GSE	0	0.0%	0.0%
Third party de-icer	0	0.0%	0.0%
Aircraft engine tests	0	0.0%	0.0%
Water	1	0.3%	0.3%
Business travel	0	0.0%	0.0%
Out of Scopes – Total	1	98.7%	0.3%
Diesel	1	98.2%	0.3%
Petrol	0.02		
Wood	0	0.5%	0.0%
Total	514		100.0%

CARBON FOOTPRINT

ANNUAL EMISSIONS TRENDS – MARKET BASED

The table below shows the figures from the charts on the previous slide, as well as the % year-on-year (y-o-y) change of the different emissions scopes.

Emissions by Scope	2019	2020	2021	2022	2023
Scope 1	44	49	35	43	33
Scope 2	0	0	0	0	0
Scopes 1 and 2	44	49	35	43	33
Scope 3	5	648	457	425	480
Outside of Scope	2	1	0	0	1
Total emissions	50	699	492	468	514

Scope 1 % y-o-y change	N/A	13%	-30%	24%	-42%
Scope 2 % y-o-y change	N/A	N/A	N/A	N/A	N/A
Scope 1 & 2 % y-o-y change	N/A	13%	-30%	24%	-42%
Scope 3 % y-o-y change	N/A	13423%	-29%	-7%	13%
Outside of Scope	N/A	-26%	-66%	11%	48%
Total % y-o-y change	N/A	1296%	-30%	-5%	7%

CARBON FOOTPRINT

ANNUAL EMISSIONS TRENDS – MARKET-BASED

Market Based tCO ₂ e	2019	2020	2021	2022	2023
Scope 1 – Total	44	49	35	43	33
Natural gas	0	0	0	0	0
Airport GSE	8	9	15	8	21
Fuel (heating and power)	32	39	17	33	11
Business travel	0	0	0	0	0
Refrigerants	0	0	0	0	0
Airport de-icer	0	0	0	0	0
Fire training	4	2	3	1	0
Scope 2 – Total	0	0	0	0	0
Airport electricity	0	0	0	0	0
Scope 3 - Total	5	648	457	425	480
Climb, Cruise and Descent (CCD)	0	207	147	147	185
Landing Take-off (LTO)	0	391	294	247	262
Passenger surface access	0	12	3	5	8
Tenant electricity	0	0	0	0	0
Electricity WTT <i>(reported since 2021)</i>	3	3	3	4	4
Electricity T&D	2	2	2	1	1
Waste	0	21	4	15	15
Staff commute	0	3	4	4	4
Third party GSE	0	0	0	0	0
Third party de-icer	0	0	0	0	0
Aircraft engine tests	N/A	N/A	N/A	0	0
Water	0	4	1	1	1
Business travel	0	5	0	1	0
Out of Scopes – Total	2	1	0	0	1
Diesel	2	0	0	0	1
Petrol	0	0	0	0	0
Wood	0	1	0	0	0
Total	50	699	492	468	514

CARBON FOOTPRINT

LOCATION BASED EMISSIONS

CARBON FOOTPRINT

SUMMARY: LOCATION BASED REPORTING

All emissions have been calculated in line with the GHG Protocol, to ACA Level 4 standard and ISO 14064-1. The emissions sources included are shown in the figure below.

528 tCO₂e/year

90.9% from scope 3 emission sources

Location Based Emissions Figures

Scope 1

“Direct Emissions”

Emissions produced from sources linked to a company's assets.

33 tCO₂e 6.2 %

Scope 2

“Indirect Emissions”

Emissions produced by the generation of electricity purchased from third parties and consumed in the company's assets.

14 tCO₂e 2.6 %

Scope 3

“Indirect Emissions”

Emissions that arise as a consequence of the activities of the company but occur from sources not owned or controlled by the company.

480 tCO₂e 90.9 %

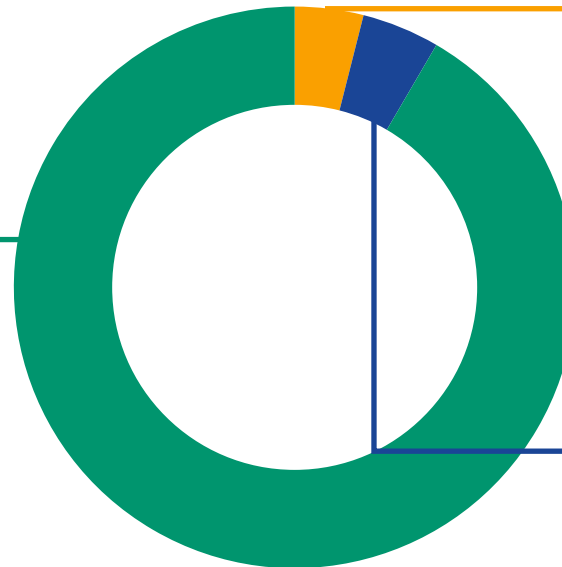

CARBON FOOTPRINT

ANNUAL SUMMARY – LOCATION BASED

6.2 %

Scope 1

2.6 %

Scope 2

90.9 %

Scope 3

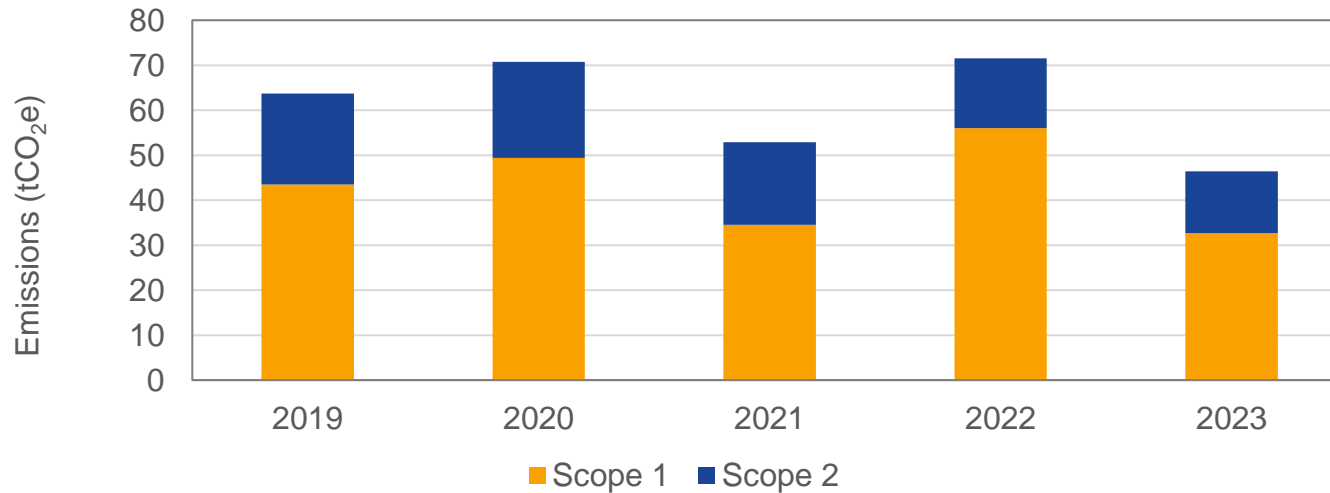
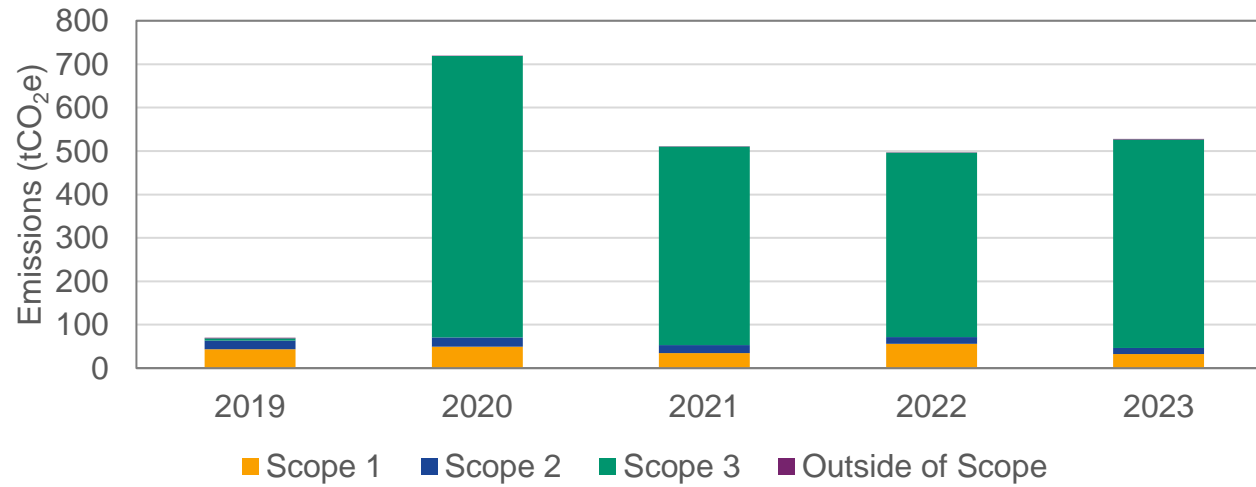

CARBON FOOTPRINT

ANNUAL SUMMARY – LOCATION BASED

The table below shows the figures from the charts on the previous slide, as well as the % year-on-year (y-o-y) change of the different emissions scopes.

Emissions by Scope	2019	2020	2021	2022	2023
Scope 1	44	49	35	43	33
Scope 2	20	21	18	16	14
Scopes 1 and 2	64	71	53	58	46
Scope 3	5	648	457	425	480
Outside of Scope	2	1	0	0	1
Total emissions	70	720	511	484	528

Scope 1 % y-o-y change	N/A	13%	-30%	24%	-42%
Scope 2 % y-o-y change	N/A	6%	-14%	-15%	-12%
Scope 1 & 2 % y-o-y change	N/A	11%	-25%	11%	-35%
Scope 3 % y-o-y change	N/A	13423%	-29%	-7%	13%
Outside of Scope	N/A	-26%	-66%	11%	48%
Total % y-o-y change	N/A	925%	-29%	-5%	6%

CARBON FOOTPRINT

ANNUAL EMISSIONS BY SOURCE

Location Based tCO2e	2019	2020	2021	2022	2023
Scope 1 – Total	44	49	35	43	33
Natural gas	0	0	0	0	0
Airport GSE	8	9	15	8	21
Fuel (heating and power)	32	39	17	33	11
Business travel	0	0	0	0	0
Refrigerants	0	0	0	0	0
Airport de-icer	0	0	0	0	0
Fire training	4	2	3	1	0
Scope 2 – Total	20	21	18	16	14
Airport electricity	20	21	18	16	14
Scope 3 - Total	5	648	457	425	480
Climb, Cruise and Descent (CCD)	0	207	147	147	185
Landing Take-off (LTO)	0	391	294	247	262
Passenger surface access	0	12	3	5	8
Tenant electricity	0	0	0	0	0
Electricity WTT <i>(reported since 2021)</i>	3	3	3	4	4
Electricity T&D	2	2	2	1	1
Waste	0	21	4	15	15
Staff commute	0	3	4	4	4
Third party GSE	0	0	0	0	0
Third party de-icer	0	0	0	0	0
Aircraft engine tests	N/A	N/A	N/A	0	0
Water	0	4	1	1	1
Business travel	0	5	0	1	0
Out of Scopes – Total	2	1	0	0	1
Diesel	2	0	0	0	1
Petrol	0	0	0	0	0
Wood	0	1	0	0	0
Total	70	720	511	484	528

KEY STATS

KEY STATS

INTENSITY METRICS COMPARISON OVER TIME - 1

Intensity metrics allow comparison over time against other factors that fluctuate and have an impact on the environmental performance of the airport. The two chosen key performance indicators are aircraft traffic movements (ATM) and passenger numbers (PAX).

This chart shows intensity metrics for Scope 1&2 kgCO₂e/PAX and kgCO₂e/ATM for both location and market based reporting methodologies. Note that the impacts of COVID-19 on airport operations led to increased carbon intensity per ATM and PAX in 2020 and 2021.

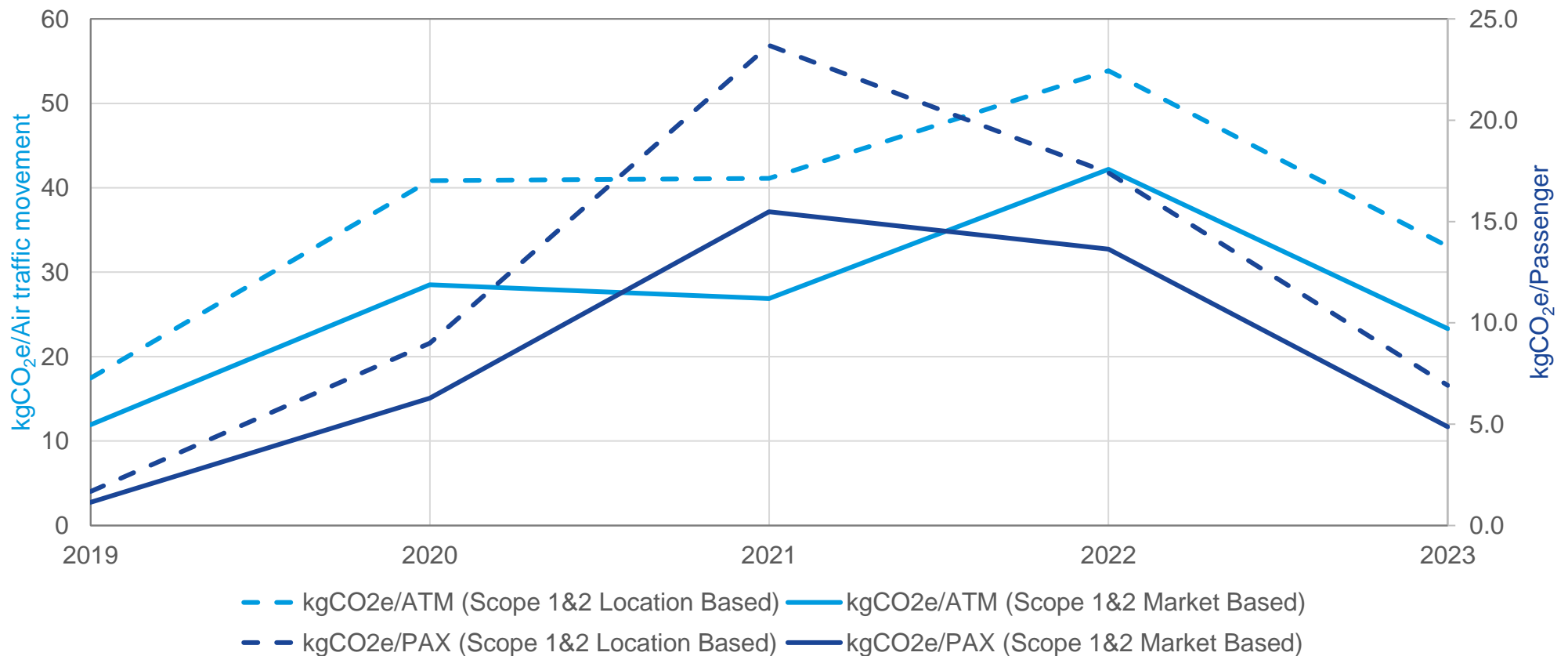

KEY STATS

INTENSITY METRICS COMPARISON OVER TIME - 2

This chart shows intensity metrics for Scope 1 & 2 kgCO₂e/passenger (PAX) and kgCO₂e/air traffic movement (ATM) for both location and market based reporting methodologies.

Note that the impacts of COVID-19 on airport operations led to increased carbon intensity per ATM and PAX in 2020 and 2021.

	2019	2020	2021	2022	2023
ATM	3,649	1,733	1,286	1,328	1,403
PAX	38,007	7,873	2,232	4,110	6,712
% Change in ATM (year-on-year)	N/A	-52.5%	-25.8%	3.3%	5.6%
% Change in PAX (year-on-year)	N/A	-79.3%	-71.6%	84.1%	63.3%

Scope 1 & 2 (tCO ₂ e) Location Based Scope	64	71	53	58	46
kgCO ₂ e/ATM	17.5	40.8	41.1	44.0	33.1
kgCO ₂ e/PAX	1.7	9.0	23.7	14.2	6.9

Scope 1 & 2 (tCO ₂ e) Market Based Scope 2	44	49	35	43	33
kgCO ₂ e/ATM*	11.9	28.5	26.9	32.3	23.3
kgCO ₂ e/PAX*	1.1	6.3	15.5	10.4	4.9

KEY STATS

THREE YEAR ROLLING AVERAGE

Level 4 of the Airport Carbon Accreditation scheme requires airports to demonstrate a reduction in their Scope 1 & 2 emissions against a three-year rolling average. Campbeltown has had a decrease in their Scope 1 & 2 emissions against the rolling average in terms of intensity based and absolute emissions as shown in the charts below.

NOTE: Due to impacts of COVID-19, 2020 data is not included within the three year rolling average when reporting these figures for ACA purposes. Reduced passenger and flight numbers in 2021 also impacts the intensity based emissions for 2021, but absolute emissions remained below the three-year rolling average.

Intensity Based Emissions (kgCO₂e/ATM)

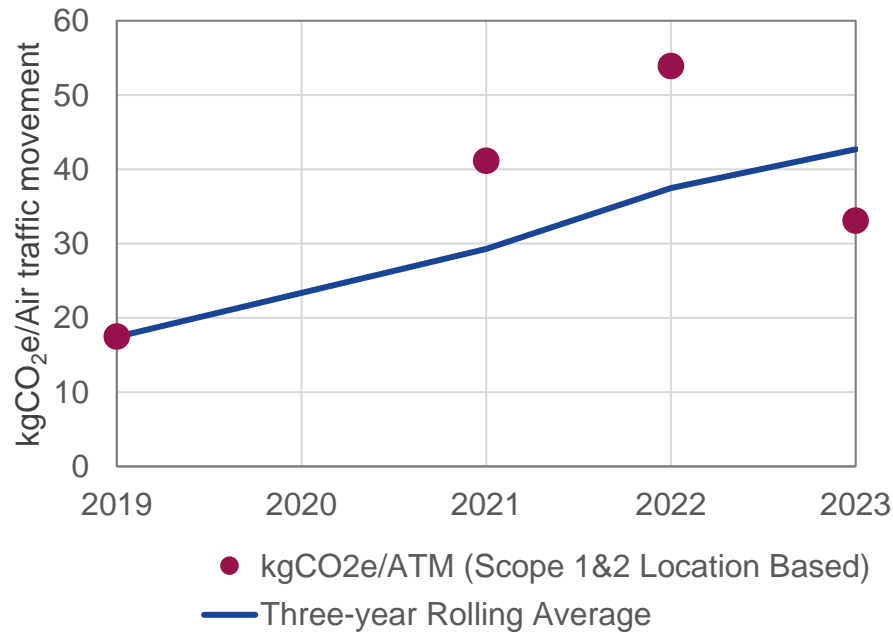

Absolute Emissions (tCO₂e)

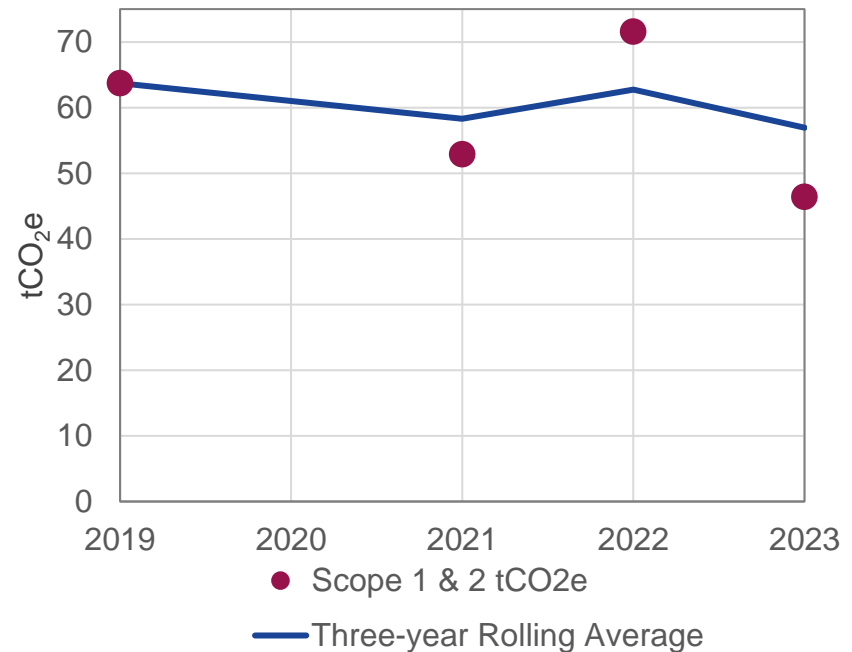

CARBON FOOTPRINT

BY EMISSION SOURCE

All Scopes carbon emissions split by source/activity

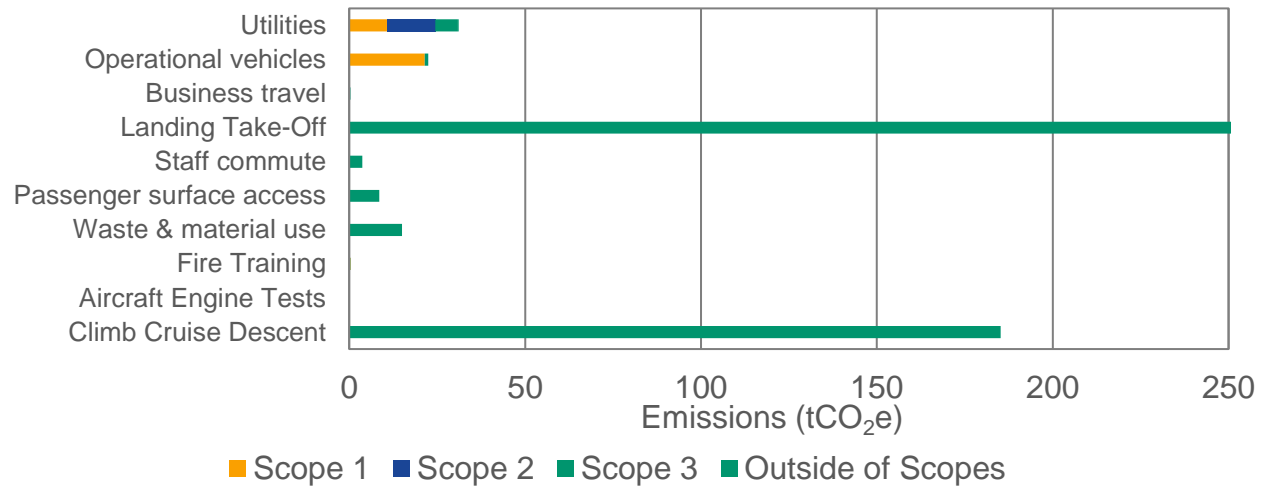

Scopes 1 and 2 carbon emissions split by source/activity

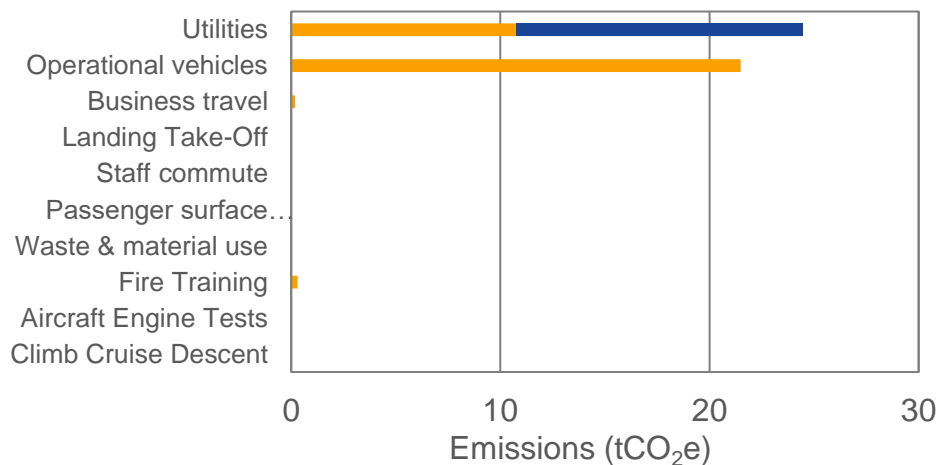

Scope 3 carbon emissions split by source/activity

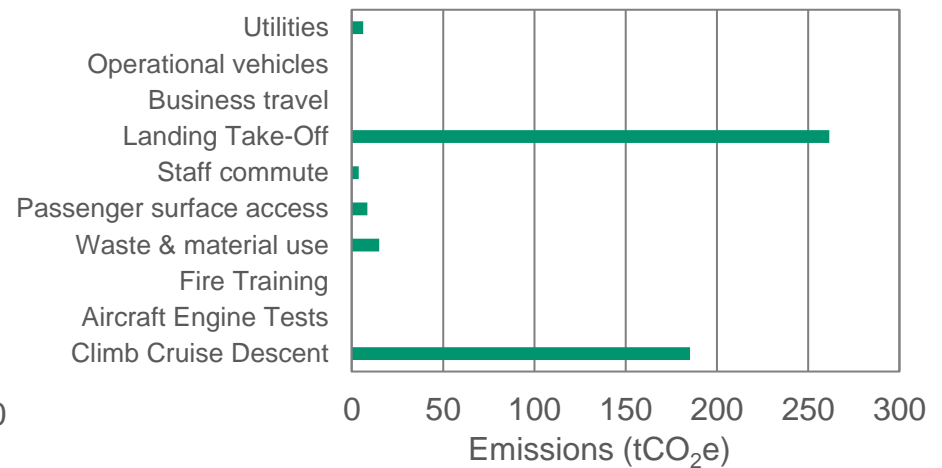

CARBON FOOTPRINT

BY EMISSIONS SOURCE

Location Based tCO ₂ e	Emissions (tCO ₂ e)	% of Scope	% of Total Emissions
Scope 1 – Total	33	100.0%	6.2%
Natural gas	0	0.0%	0.0%
Airport GSE	21	65.7%	4.1%
Fuel (heating and power)	11	32.8%	2.0%
Business travel	0	0.5%	0.0%
Refrigerants	0	0.0%	0.0%
Airport de-icer	0	0.0%	0.0%
Fire training	0	0.9%	0.1%
Scope 2 – Total	14	100.0%	2.6%
Airport electricity	14	100.0%	2.6%
Scope 3 - Total	480	100.0%	90.9%
Climb, Cruise and Descent (CCD)	185	38.6%	35.1%
Landing Take-off (LTO)	262	54.5%	49.5%
Passenger surface access	8	1.8%	1.6%
Tenant electricity	0	0.0%	0.0%
Electricity WTT (<i>reported since 2021</i>)	4	0.7%	0.7%
Electricity T&D	1	0.3%	0.2%
Waste	15	3.1%	2.8%
Staff commute	4	0.8%	0.7%
Third party GSE	0	0.0%	0.0%
Third party de-icer	0	0.0%	0.00%
Aircraft engine tests	0	0.0%	0.00%
Water	1	0.3%	0.266%
Business travel	0	0.0%	0.00%
Out of Scopes – Total	1.40	98.7%	0.3%
Diesel	1.37	98.2%	0.26%
Petrol	0.02	0.0%	0.00%
Wood	0.007	0.5%	0.0014%
Total	528		100.0%

CARBON FOOTPRINT

SCOPE 1 EMISSION SOURCES

Scope 1 emissions are produced from sources linked to a company's assets.

For Campbeltown airport, the major emissions sources in this category include the emissions from natural gas used in heating systems and airport owned operational vehicle fuel, other smaller sources include fuel burnt during fire training.

33 tCO₂e/year

6.2 % of total emissions

Location Based Emissions Figures

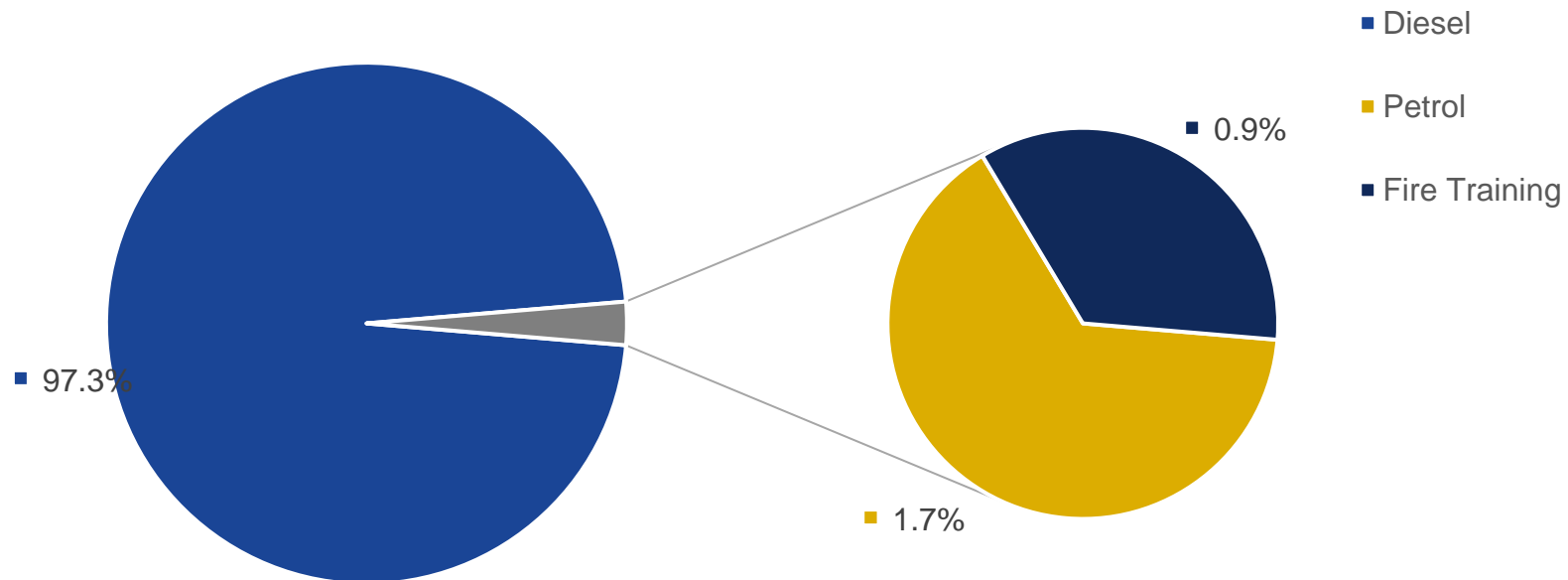

CARBON FOOTPRINT

SCOPE 2 LOCATION AND MARKET BASED EMISSIONS

Scope 2 emissions relate to the electricity consumption at the airport. These can be calculated using the following two methodologies:

- **Location-based method;** this reflects the average emissions intensity of macro-scale (regional/national) electricity grids where energy consumption occurs. Companies reporting using this method should use the regional/National Grid average emission factor. In the UK, this would be sourced from the Defra/DECC UK Government conversion factors for Company Reporting.
- **Market-based method;** this reflects the emissions from the electricity that a company is purchasing. Energy suppliers in the EU are already required, by law, to disclose to consumers the fuel mix and GHG emissions associated with their portfolio or tariffs. During Jan-December 2022, Campbeltown purchased green electricity with all consumption and transmissions and distribution losses covered by renewable energy guarantees of origin (REGO) certificates. Therefore, electricity emissions are reported as zero carbon under the market based methodology.

	Location-based (tCO ₂ e)	Market-based (tCO ₂)
Airport Electricity Emissions (Scope 2)	14	0

CARBON FOOTPRINT

SCOPE 2 ELECTRICITY CONSUMPTION AND CARBON EMISSIONS

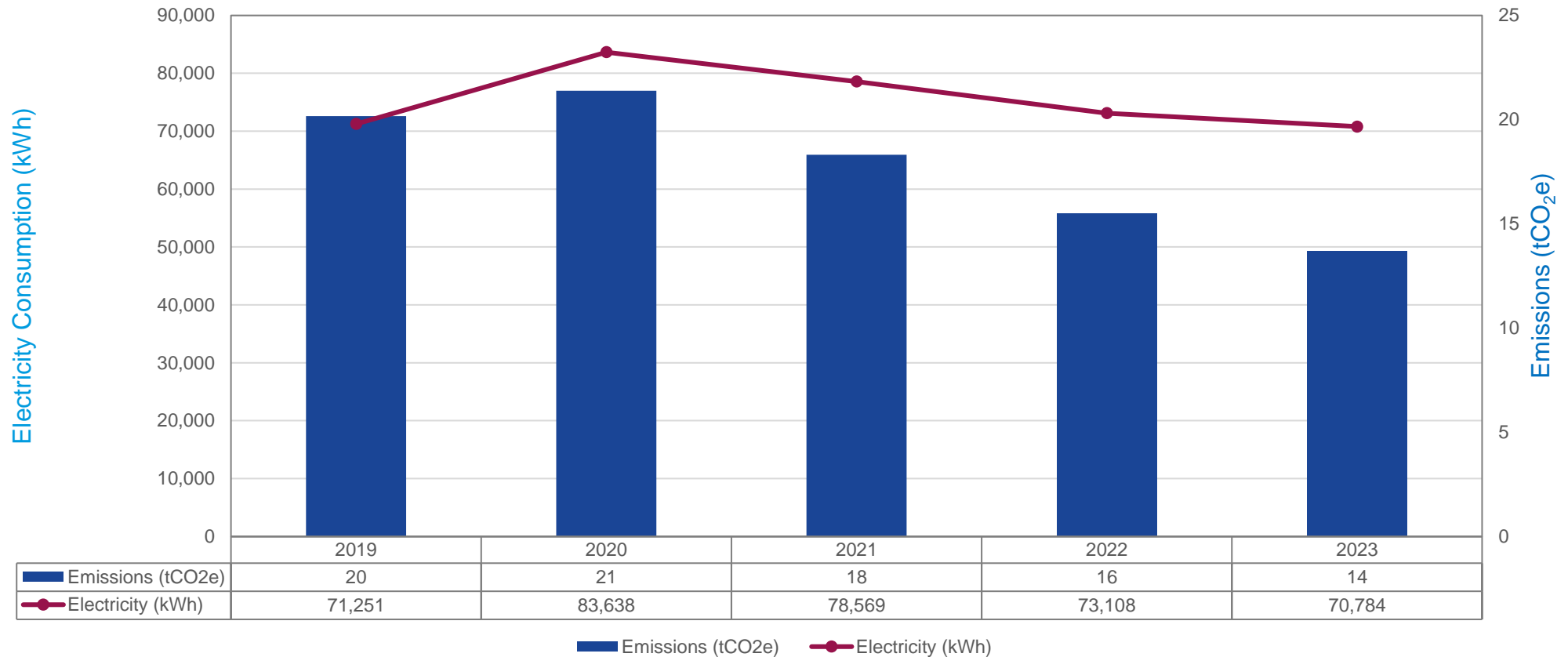

The emissions in the figure above are the location based electricity emissions. The majority of savings in emissions is due to the ongoing decarbonisation of the UK national grid.

Note: The figures for electricity consumption above include both airport (Scope 2) and tenant (Scope 3) electricity use. All emission figures exclude emissions from transmission and distribution (T&D) losses.

CARBON FOOTPRINT

SCOPE 3 EMISSION SOURCES

Scope 3 emissions are those that arise as a consequence of the activities of the company, but occur from sources not owned or controlled by the company.

For Campbeltown Airport, the major emission source in this category is emissions from aircrafts. Other sources include waste and water supply treatment, third party electricity and passenger surface access.

480 tCO₂e/year

90.9% of total emissions

Location Based Emissions Figures

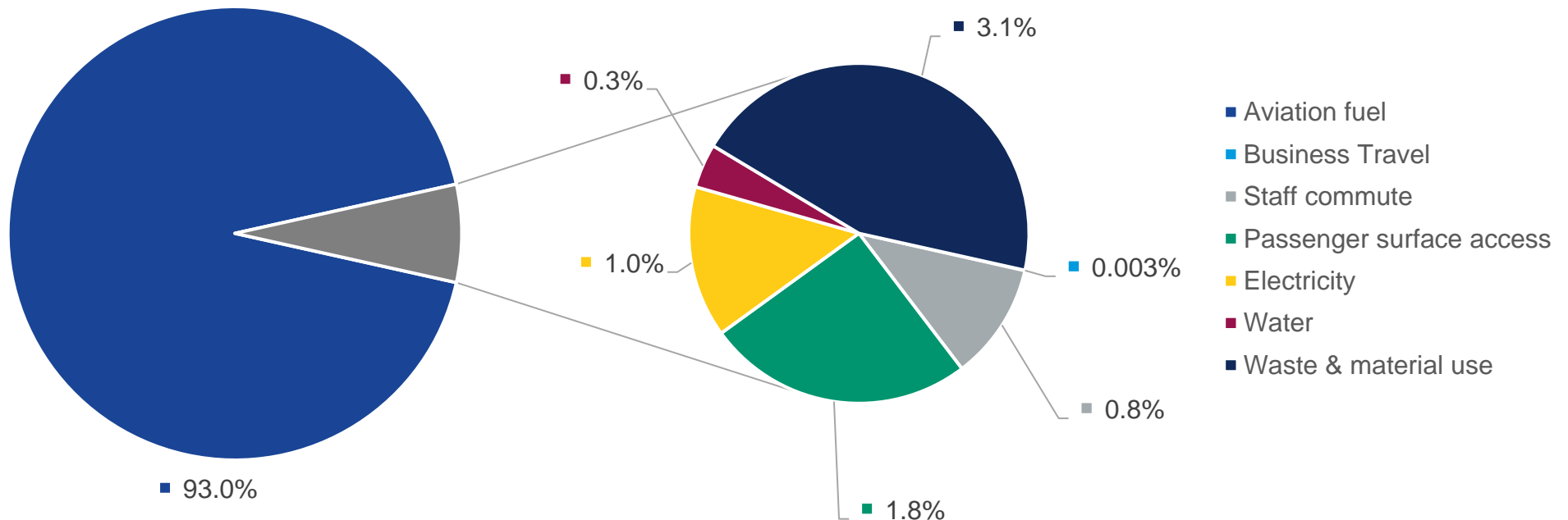

CARBON FOOTPRINT

ANNUAL EMISSIONS TRENDS

In comparison to 2022, emissions have increased by 6% in 2023.

Emissions sources with the largest changes from 2022:

1. Aviation fuel (Scope 3) emissions has **increased** by 14% due to the increase of air traffic movements.
2. Passenger surface access (Scope 3) emissions have **increased** by 63%. This correlates to the increase in passengers flying from Campbeltown.
3. Diesel (Scope 1 & 3) emissions have **increased** 51%.
4. Electricity emissions have **decreased** by 13%.
5. Business travel (Scope 3) emissions have **decreased** by 98%

CARBON FOOTPRINT

ANNUAL SUMMARY WITHOUT CCD



9.5 %
Scope 1

4.0%
Scope 2

86.1%
Scope 3

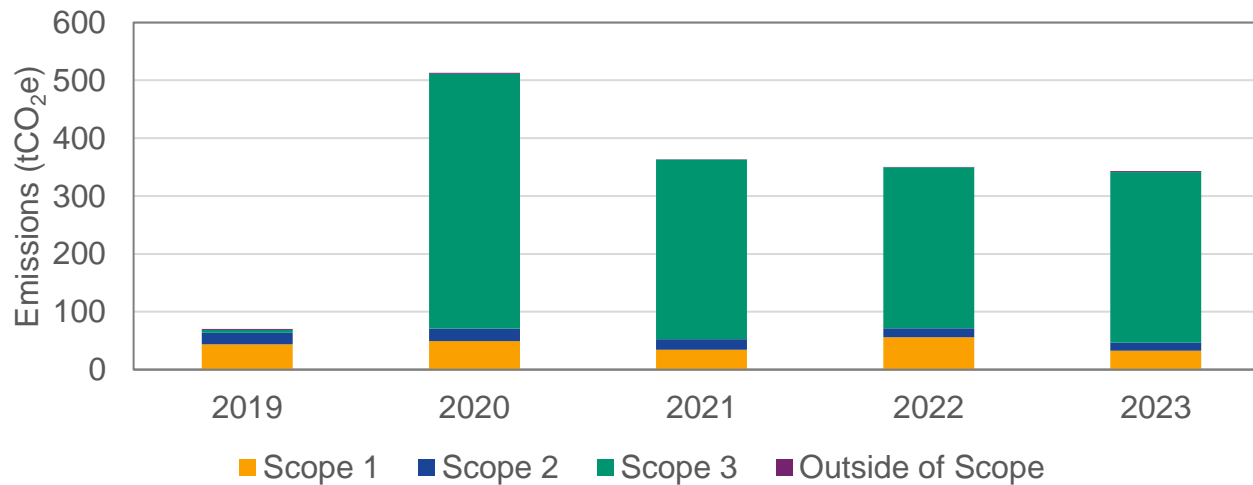

METHODOLOGY

THE FOLLOWING SECTIONS PROVIDE A SUMMARY OF THE METHODOLOGY ADOPTED BY RICARDO TO CALCULATE THE 2022 FOOTPRINT FOR Campbeltown

The standard approach to carbon footprinting is to use the Greenhouse Gas (GHG) Protocol Corporate Accounting and Reporting Standard developed by World Business Council for Sustainable Development (WBCSD) and the World Resources Institute (WRI); this sets out a corporate accounting and reporting methodology for GHGs.

SCOPE 1 EMISSIONS

Scope 1 emissions are defined as direct GHG emissions arising from sources that are owned or controlled by the company. The emissions result from activities that the company can have direct influence on through its actions. Airports' emissions that are included are: natural gas use, company owned vehicles fuel use, fuel use for business travel, refrigerant gas use (from leaks during maintenance or malfunction), wood pallets and diesel use for fire training, propane combustion and kerosene combustion.

SCOPE 2 EMISSIONS

Scope 2 emissions are associated with the use of electricity imported from the grid or from a third-party supplier of energy in the form of heat or electricity. These indirect GHG emissions are due to upstream emissions from the production and delivery of fuel to power stations. The airport can influence the amount of electricity it uses; however, it has little control over the generation of the electricity and these emissions are therefore classed as Scope 2.

SCOPE 3 EMISSIONS

Scope 3 emissions are defined as those arising as an indirect consequence of the use of goods or services provided by the company. The airport does have some influence over Scope 3 emissions but the activities are not under its control. Sources included by the airport include aircraft (all aircraft movements up to a height of 1,000m above aerodrome level), employees commuting to the airport, passenger surface access to the airport, airside vehicle activities by third party operators, waste disposal, water (supply and treatment), airport business travel and engine testing.

OUTSIDE OF SCOPE EMISSIONS

As per UK Government GHG Conversion Factors for Company Reporting guidance, Outside of Scope factors have been used to account for the direct carbon dioxide (CO₂) impact of burning biomass and biofuels. The emissions are labelled 'outside of scope' because the Scope 1 impact of these fuels has been determined to be a net '0' (since the fuel source itself absorbs an equivalent amount of CO₂ during the growth phase as the amount of CO₂ released through combustion). As a result, full reporting of any fuel from a biogenic source have included the 'outside of scope' CO₂ value, documented to ensure complete accounting for the emissions created.

METHODOLOGY

The uncertainties associated with carbon footprint calculations can be broadly categorised into scientific uncertainty and estimation uncertainty. Scientific uncertainty arises when the science of the actual emission and/or removal process is not completely understood. For example GWP values involve significant scientific uncertainty. Estimation uncertainty arises any time GHG emissions are quantified. Estimations have been made within this footprint where areas have uncertainty have arisen.

PASSENGER SURFACE ACCESS

Emissions are based on a survey conducted in 2020. The survey provided the mode of passenger transport and home postcodes of those in the sample. The first part of each postcode was used to calculate the distance travelled to the airport. The distance by road was used as a conservative estimate and Island locations were excluded from the analysis as these passengers would most likely be arriving by air. This was then scaled to the total number of passengers throughout the 22/23 financial year.

- **Transport mode:** Where multiple modes of travel were provided, the main mode was taken as the primary mode
- **Distance travelled:** Google maps has been used to calculate the distance travelled between Campbeltown and the identified largest town per county – using fastest route by car for Wednesday midday. Where no location was provided, the weighted average of all possible routes has been used.

The following assumptions were made to for transport modes:

- **Private car journeys:** Engine type split from latest statistics from [UK Government for South East of England](#).
- **Taxi Journeys:** 33 out of 110 hackney taxis that make journeys to the airport are now battery electric vehicles.
- **Coach journeys:** There are three service providers who transfer passengers to the airport: Stagecoach, National Express and Arriva. The engine type of these fleets has been provided by the service providers, and for those with the lower emission Euro-6 compliant engines an [appropriate emissions factor](#) was used to reflect the reduction in emissions from these journeys.
- **Other journey types:** For other journey types, the best matching emissions factor from the UK Government GHG Conversion Factors for Company Reporting has been used.

METHODOLOGY

LANDING TAKE-OFF CYCLE (LTO)

The LTO cycle is split into several stages which are shown in the diagram below, and consist of all fuel consuming movements below 1,000m altitude. The emissions from aircraft above 1,000m are calculated separately as Climb, Cruise and Descent (CCD) emissions, and have been included within Campbeltown Airport's footprint.

Fuel usage for each aircraft from the LTO cycle are calculated by using fuel burn rates (kg/second) from the [ICAO Databank](#) (Jet engines) or [FOCA Aircraft Piston Engine database](#) (Piston engines) for each aircraft, multiplied by the time the aircraft spends in each section of the LTO cycle (e.g. Taxi Out, Initial Climb). Fuel use is then converted to carbon emissions using the emissions factor for aviation fuel provided by the UK Government.

Additional efforts have been made to improve the accuracy of the LTO calculations in 2023 to reflect the impact of aircraft fuel efficiency improvements that were not otherwise captured by the methodology used in previous years.

One improvement to the methodology was accounting for the fuel savings from the use of wingtips on aircraft. New designs for the tips of the aircraft wings can reduce drag and improve fuel efficiency. An example of a modern wingtip design is shown below.

Wingtips can reduce fuel burn by [4-6%](#) for larger aircraft, which reduces the carbon emissions by the same amount. A 4% reduction in fuel use was used as a conservative estimate of fuel burn savings for the calculations for Campbeltown Airport's LTO emissions. Note that wing tip fuel burn savings only apply to the following LTO stages: Take-off, Initial climb, Climb out.

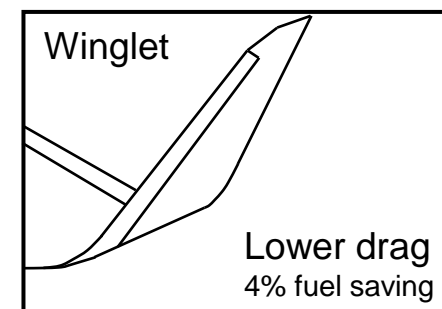
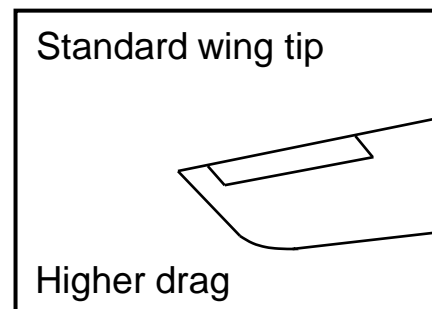
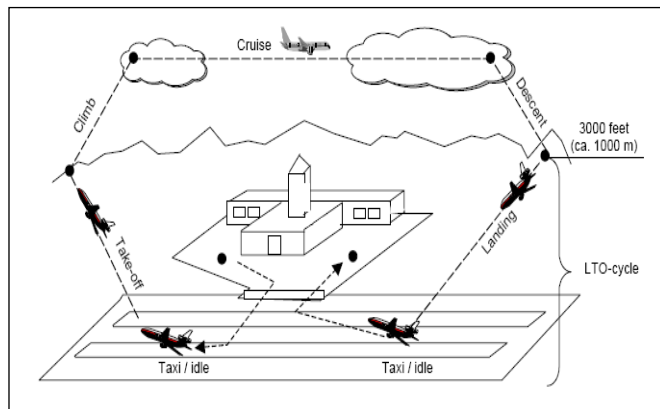

METHODOLOGY

CLIMB, CRUISE AND DESCENT (CCD)

The ACA scheme outline three methodologies for the allocation of CCD emissions:

1. Half way approach: Where emissions from half of the distance of all flights going to/from the airports is allocated to the reporting airport.
2. Departing only approach: Emissions for the full flight distance for departing aircraft are allocated for the reporting airport.
3. Fuel sales approach: Emissions for all fuel sold at the airport is allocated to the reporting airport.

Of the three options above, it was decided to utilise the first approach as this is perceived to be the most neutral and comprehensive methodology.

Data provided by Campbeltown included the following information for each aircraft movement in 2023: Carrier, aircraft ICAO code, Arriving/departing, destination/origin airport, and date of movement.

Flight distance was calculated with the great circle equation, utilising the origin and destination airport latitude and longitude. This flight distance was uplifted by 5.5% to reflect the fact that aircraft do not fly in a perfect straight line from one airport to another. This figure has come from studies carried out by Ricardo Energy and Environment for the UK Department for Transport, and is an update to the commonly used figure of 9%.

Fuel kg/km in-flight for each aircraft type is calculated using data from the EMEP-EEA Fuel Database.

Emissions are calculated from the fuel consumption per flight, using the BEIS emissions factor for aviation turbine fuel.

No non-carbon warming impacts have been taken into account as part of the CCD emissions.

LANDING TAKE-OFF CYCLE (LTO)

See [previous slide](#) with details of updates to methodology this year.

METHODOLOGY

BUSINESS TRAVEL

Accounts data was provided for business travel (Scope 1 & 3). All transport mode data was provided in £ value and converted to distance travelled using the cost/km from [Carbon Footprint and Project Register Tool](#) (CFPRT). The CFPRT collates cost data for all forms of public transport across the UK, and is managed and updated by Sustainable Network Scotland and Resource Efficient Scotland.

Distance travelled was converted to emissions using the appropriate emissions factors from UK Government GHG Conversion Factors for Company Reporting.

STAFF COMMUTE

For staff commute, the 2019 staff travel survey data was utilised. The final data was scaled to the full Campbeltown staff in 2023. The survey respondents provided information on their modes of transport, distance travelled to work and number of days worked per week. This was scaled up to reflect a full working year by assuming that there are 250 working days per year (Mon-Fri) and each staff member has 25 days of leave per year.

Total annual distance travelled was converted to emissions using the appropriate emissions factors from UK Government GHG Conversion Factors for Company Reporting.

UTILITIES

Utility emissions include: Electricity (Campbeltown Airport and third parties), natural gas, fuel used for heating and power, water supply and wastewater treatment, de-icer usage (aircraft and ground), and refrigerant lost to atmosphere from cooling systems. Data was provided by Campbeltown Airport and converted to emissions using the appropriate emissions factors from UK Government GHG Conversion Factors for Company Reporting.

OPERATIONAL VEHICLES

Operational vehicle fuel use was calculated by using fuel volume data provided by Campbeltown Airport for their own and third party operations, including fuel used in off-road construction vehicles. Fuel volume was converted to emissions using the appropriate emissions factors from UK Government GHG Conversion Factors for Company Reporting.

WASTE

Tonnage of waste was assumed based on bin collection frequency and size as no raw data was available. Tonnes of different types of waste in various size of containers were based on conversion factors from the Department for Environment, Food & Rural Affairs (DEFRA) UK Waste Classification Scheme. The emissions for waste disposal and virgin material production were calculated by using the appropriate factors from UK Government GHG Conversion Factors for Company Reporting.



Creating a world fit for the future
www.ricardo.com

Ricardo

The Gemini Building

Fermi Avenue

Harwell

Didcot

OX11 0QR

E: enquiry-ee@ricardo.com

T: +44 (0) 1235 753000